

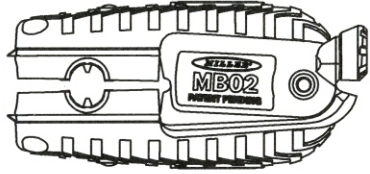

A RIPLEY® BRAND



MB02

3-15 mm CABLE SLITTER INSTRUCTION SHEET



LONGITUDINAL CUT

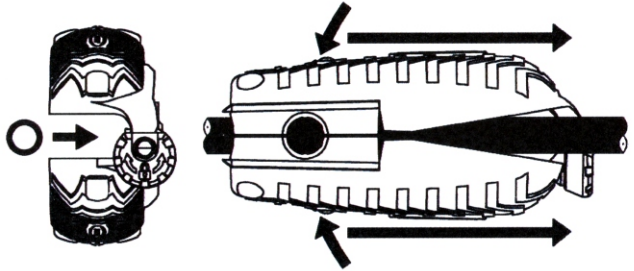

RING CUT

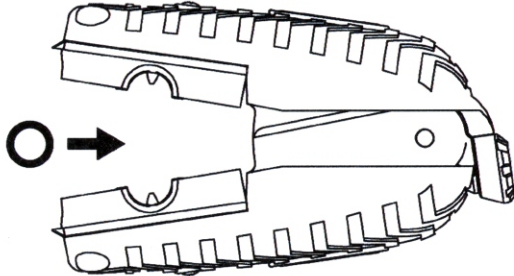

ROTATE 180° AND
BACK 1+ TIMES

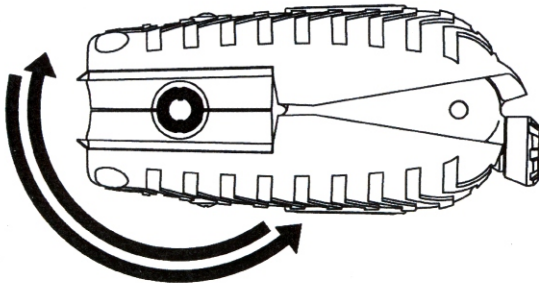

TRAY REPLACEMENT

INSERT

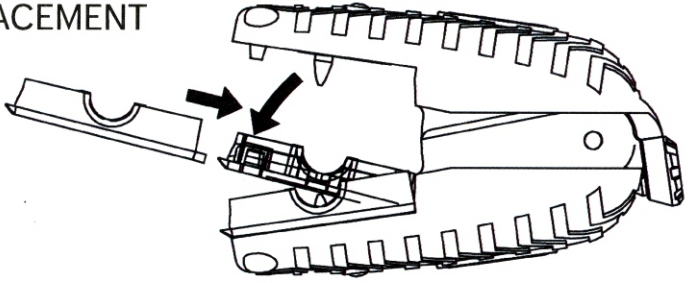

EJECT

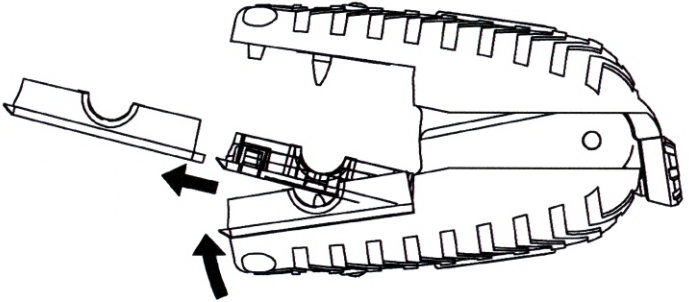

TRAY OVERVIEW

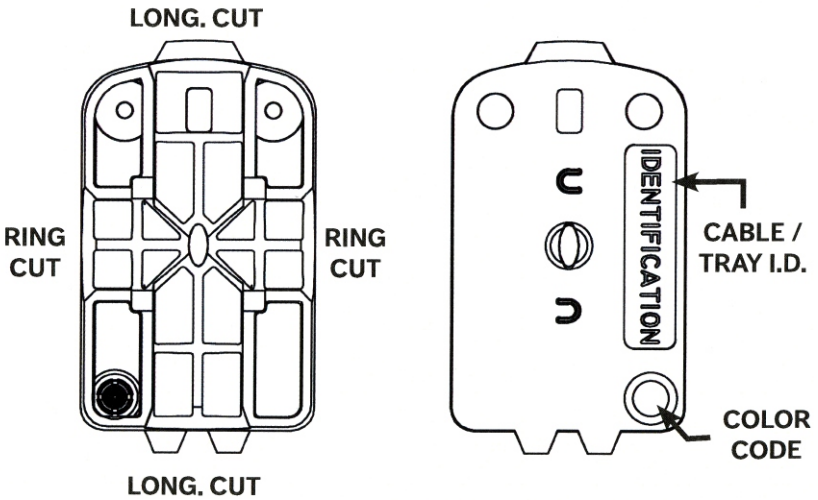

REPLACEMENT BLADE KIT: MB02-7500

WWW.RIPLEY-TOOLS.COM

MB02-6000